

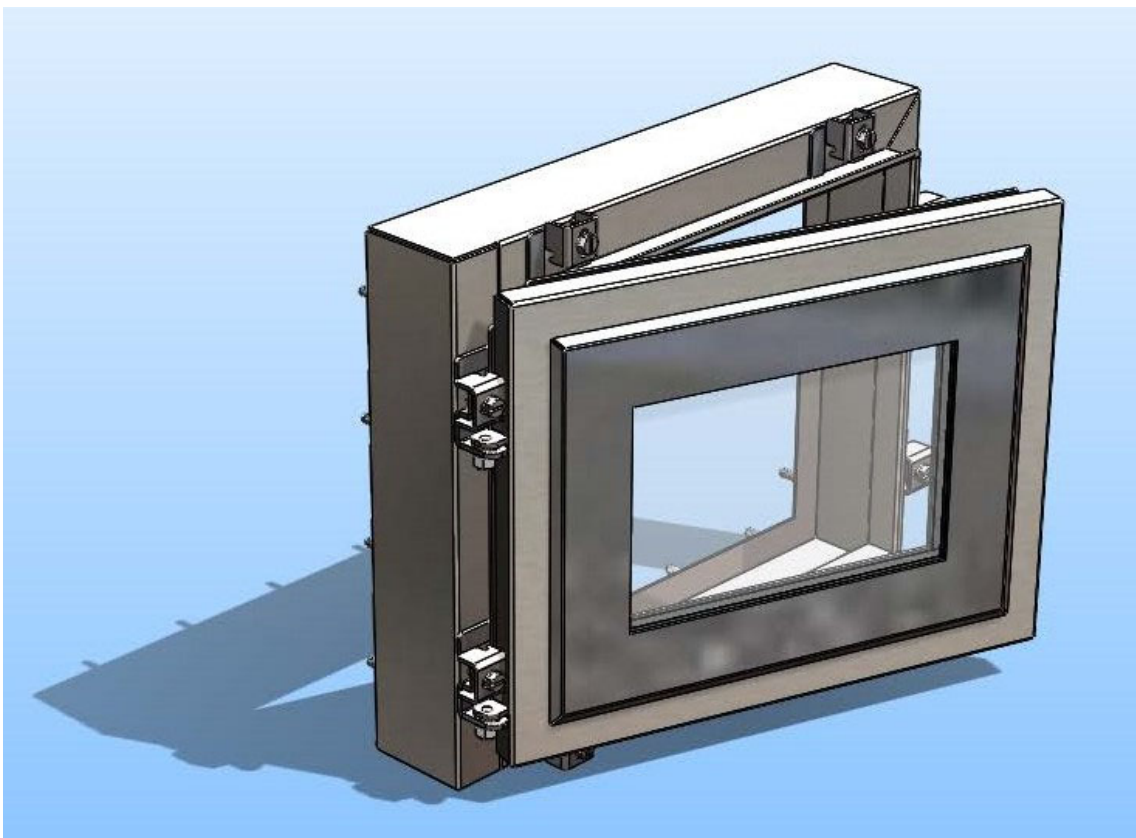

Increased Safety Window Kits



IOM Manual

This page intentionally left blank

Copyright Notice:

This document contains information proprietary to Purge Solutions, Inc. with all rights reserved worldwide. Any reproduction or disclosure of this publication, or any part thereof, to persons other than Purge Solutions, Inc. personnel or customers is strictly prohibited, except by written permission of Purge Solutions, Inc. Unauthorized use, disclosure, reproduction, or translation of this publication will result in Purge Solutions, Inc. exercising maximum possible legal action against all persons and / or organizations involved.

Disclaimer:

Purge Solutions, Inc. makes every effort to ensure the accuracy and completeness of this manual. However, we cannot be responsible for errors, omissions, or any loss of data as the results of errors or omissions. We therefore make no representations or warranties with respect to the contents hereof. Further, Purge Solutions, Inc. reserves the right to revise this publication and to make changes in the content hereof, without obligation to notify any person or organization of such revision or changes.

Shipment Arrival Procedures:

This shipment has been thoroughly inspected at the factory prior to its delivery to the carrier. After the shipment is picked up by the carrier, it becomes their responsibility. When the shipment arrives, make certain that it is undamaged and complete.

Patent Notice:

Manufactured under United States, Worldwide Patents, and Patents Pending.

Trademark Information:

Purge Solutions, Inc. and its logo(s) are trademark(s) of Purge Solutions, Inc.

Table of Contents

Legal Notices and Revision History Inside
front cover

Section 1

How To Use This Manual	1
Safety Considerations	1
Label Definition Table	2
Locating Information	2
General Safety	3
General Precautions	3
Electrical Power	4
System Location	4

Section 2

Specifications	5
Certifications and Standards	5
Environmental Conditions	5
Features	5
Material Specifications	5
Increased Safety Window Kits Model Matrix	6

Section 3

Installation	9
Increased Safety Window Kit Mounting Drawings	12

Section 4

Getting Help	27
Warranty	28

Section 1

How to Use This Manual

Safety Considerations:

This chapter includes important information that must be read and understood by all persons installing, using, or maintaining this equipment. While this manual is designed to aid personnel in the correct and safe installation, operation, and maintenance of the systems described. Personnel must consider all actions and procedures for potential hazards or conditions that may not have been anticipated in the written procedures. If a procedure cannot be performed safely, it must not be performed until appropriate actions can be taken to ensure the safety of equipment and personnel. The procedures in this manual are not designed to replace or supersede required or common sense safety practices. All safety warnings listed in any documents applicable to equipment and parts used in or with the system described in this manual must be read and heeded before commencing work on any part of the system.



NOTE: Refer to all ATEX, IECEx and UKEx certificates for any Special Conditions of Use. If the sign “X” is placed after the certificate number, it indicates that the equipment or protective system is subject to special conditions for safe use specified in the schedule of the certificate.



NOTE: Review all material and safety information in this manual and install in accordance with this document and all other applicable ATEX, IECEx and UKEx standards.





WARNING: Failure to follow appropriate safety procedures or inappropriate use of the equipment described in this manual can lead to injury of personnel or equipment damage.



WARNING – EXPLOSION HAZARD – Do not disconnect equipment unless power has been removed or the area is known to be non-hazardous.

The following symbols are used throughout this manual to alert users to potential hazards or important information. ***Failure to heed the warnings and cautions listed herein can lead to injury and equipment damage.***

Document Label Definitions Used to Indicate Potential Hazards		
Symbol	Label	Description
	WARNING:	Consists of conditions, practices, or procedures that must be observed to prevent injury or equipment damage.
	CAUTION:	Risk of electric shock or high temperature parts may result in injury if proper precautions are not taken.
	NOTE:	Emphasizes important or essential information.

Locating Information:



NOTE: *In the interest of completeness, manuals and drawings included with the system may provide information pertaining to options not included with your equipment. Information in application notes supersedes general information in these documents. Information can be located in this manual using any of the following aids.*

1. Table of Contents
2. Getting Help

General Safety:

This section contains general safety and operating information applicable to electrical equipment installed within hazardous locations. This information must be understood by all persons installing, using, or maintaining the electrical equipment. This information is designed to aid personnel in safe installation, operation, and maintenance of any Increased Safety Window Kits offered by Purge Solutions, Inc. It is not designed to replace or limit appropriate safety measures applicable to work performed by personnel. Any additional safety and operating measures that are required must be determined by and followed by personnel performing work on the electrical equipment.



WARNING: *Deviation from the specified instruction or procedure steps can result in equipment malfunction, equipment damage, or injury to personnel.*



WARNING: *Return unit to factory for any repairs or replacement of parts, customer not permitted. This will void all warranties and hazardous area certification(s).*

General Precautions:

Protective eyewear (*glasses with side shields or goggles as appropriate*) must be worn when servicing any part of electrical equipment. Hot components should be allowed to cool before servicing if possible. Other appropriate equipment or clothing must be used as required by the type of work performed. All applicable regulations and procedures must be followed for the work performed. **Before** beginning any work on the equipment, carefully consider all the potential hazards and ensure that appropriate measures are taken to prevent injury to personnel or equipment damage.



CAUTION: *Electrical equipment components may be hot even when power is not applied. Take appropriate precautions to prevent injury from contact with hot items.*



CAUTION: *Applicable permits must be obtained and appropriate precautions must be taken to prevent possible injury to personnel or equipment damage when installing or maintaining this equipment.*

Electrical Power:

Appropriate precautions must be taken to prevent sparks that may ignite combustible materials that may be present in the enclosure environment that the Increased Safety Window Kits will be installed. Precautions must also be taken to prevent electrical shock if the enclosure is opened. Power circuit breakers and wiring must be sized properly for the required current. All wiring installations must meet applicable electrical codes.

System Location:

The Purge Solutions, Inc. Increased Safety Window Kit must not be installed in an area classification for which it is not rated and must be protected from temperature extremes and potentially high vibration. The Increased Safety Window Kit must be attached securely and appropriately at its final installation as instructed in this manual.

Section 2

Specifications

Certifications & Standards

Certified for installation and use to ATEX, IECEx and UKEx for
II 2 G Ex eb IIC Gb IP66

For Zone 1 / Category 2 gas hazardous locations

II 2 D Ex tb IIIC Db IP66

For Zone 1 / Category 2 dust hazardous locations

ATEX Certification Number = ITS-I21 ATEX 30195U

IECEX Certification Number = IECEX ITS 12.0050U

UKEX Certificate Number = ITS21 UKEX0218U

Standards = IEC / EN 60079-0, IEC / EN 60079-7 and IEC / EN 60079-31

Environmental Conditions

Operating Temperature Range	- 40°F to 176°F (- 40°C to 80°C)
Storage Temperature Range	- 58°F to 194°F (- 50°C to 90°C)
Used and Mounted	For Indoor and Outdoor Use
Ingress Protection	IP66

Material Specification, Finishes & Features

Non-opening models Bezel machined from plate available in Anodized Aluminum

Non-opening models Bezel machined from plate available in 316 Stainless Steel

Opening and Non-opening models fabricated from type 304 stainless steel sheet metal
with brushed finish

Opening and Non-opening models fabricated from type 316L stainless steel sheet metal
with brushed finish

Opening and Non-opening models fabricated from mild carbon steel and powder coated
RAL7025 light gray finish

Opening and Non-opening models fabricated from type 5052 H-32 aluminum sheet metal
and powder coated RAL7025 light gray finish

All seals are Silicone O-Rings or strip gasket

All stainless mounting hardware is included, torque levels in Section 3, Step 7A and 7b

Non-Opening, Machined Bezel, Increased Safety Window Kits, Model Number Matrix

Window Viewing Size	Bezel Material	Model Number
0.98 (24.9) x 1.88 (47.8)	Black Anodized Aluminum	PSO-1/32DINW-A
1.88 (47.8) x 1.88 (47.8)	Black Anodized Aluminum	PSO-1/16DINW-A
1.88 (47.8) x 3.76 (95.5)	Black Anodized Aluminum	PSO-1/8DINW-A
3.76 (95.5) x 3.76 (95.5)	Black Anodized Aluminum	PSO-1/4DINW-A
7.25 (184.2) x 10.00 (254.00)	Black Anodized Aluminum	PSO-XLW-A
0.98 (24.9) x 1.88 (47.8)	316 Stainless Steel	PSO-1/32DINW-S
1.88 (47.8) x 1.88 (47.8)	316 Stainless Steel	PSO-1/16DINW-S
1.88 (47.8) x 3.76 (95.5)	316 Stainless Steel	PSO-1/8DINW-S
3.76 (95.5) x 3.76 (95.5)	316 Stainless Steel	PSO-1/4DINW-S
7.25 (184.2) x 10.00 (254.00)	316 Stainless Steel	PSO-XLW-S

Non-Opening, Machined Bezel, Increased Safety Window Kit, Enclosure Mounting Details

Window Viewing Size	Enclosure Hole Mounting Details		Window Kit Overall Size
	Drawing #	Page #	
0.98 (24.9) x 1.88 (47.8)	MM-11173-A	12	3.9 x 3.0 x 0.8 (100 x 77 x 21)
1.88 (47.8) x 1.88 (47.8)	MM-11172-A	13	3.9 x 3.9 x 0.8 (100 x 100 x 21)
1.88 (47.8) x 3.76 (95.5)	MM-11171-A	14	5.8 x 3.9 x 0.8 (148 x 100 x 21)
3.76 (95.5) x 3.76 (95.5)	MM-11170-A	15	5.8 x 5.8 x 0.8 (148 x 148 x 21)
7.25 (184.2) x 10.00 (254.00)	MM-11169-A	16	12.0 x 9.3 x 0.8 (305 x 237 x 21)

**Opening and Non-Opening, Sheet Metal,
Increased Safety Window Kits, Model Number
Matrix**

PSISW- 2 N 1

Purge Solutions
Increased Safety
Window Kit

WINDOW VIEWING SIZE

1 = 6.00 x 9.00 (152.4 x 228.6)
2 = 8.75 x 14.25 (222.3 x 362.0)
3 = 11.50 x 19.50 (292.1 x 495.3)
4 = 16.00 x 25.00 (406.4 x 635.0)
5 = 20.00 x 30.00 (508.0 x 762.0)

MATERIAL AND FINISH

1 = 304 Stainless Steel, Brushed
2 = 316 Stainless Steel, Brushed
3 = Carbon Steel, Powder Coated
4 = Aluminum, Powder Coated

TYPE

O = Opening
N = Non-Opening



NOTE: Window Viewing Size, Type, Material and Finish selections are made by end user to meet final application requirement (MODEL NUMBER SHOWN ABOVE IS AN EXAMPLE).

**Non-Opening, Standard Size, Sheet Metal
Increased Safety Window Kit, Enclosure
Mounting Details**

Viewing Size	Enclosure Hole Mounting Details		Window Kit Overall Size
	Drawing #	Page #	
6 x 9 (152 x 229)	MM-11290-A	17	10.2 x 13.2 x 0.9 (259 x 335 x 23)
8.75 x 14.25 (229 x 305)	MM-11291-A	18	13.0 x 18.5 x 0.9 (330 x 470 x 23)
11.5 x 19.5 (305 x 381)	MM-11292-A	19	15.7 x 23.7 x 0.9 (399 x 602 x 23)
16 x 25 (406 x 635)	MM-11293-A	20	20.2 x 29.2 x 0.9 (513 x 742 x 23)
20 x 30 (508 x 762)	MM-11294-A	21	24.2 x 34.2 x 0.9 (615 x 869 x 23)

**Opening, Standard Size, Sheet Metal,
Increased Safety Window Kit, Enclosure
Mounting Details**

Viewing Size	Enclosure Hole Mounting Details		Window Kit Overall Size
	Drawing #	Page #	
6 x 9 (152 x 229)	MM-11295-A	22	14.0 x 16.9 x 4.4 (356 x 429 x 112)
8.75 x 14.25 (229 x 305)	MM-11296-A	23	16.2 x 22.6 x 4.4 (412 x 574 x 112)
11.5 x 19.5 (305 x 381)	MM-11297-A	24	18.9 x 27.9 x 4.4 (480 x 709 x 112)
16 x 25 (406 x 635)	MM-11298-A	25	24.9 x 32.4 x 4.4 (633 x 823 x 112)
20 x 30 (508 x 762)	MM-11299-A	26	27.3 x 37.4 x 4.4 (693 x 950 x 112)

Section 3

Installation



WARNING: Before attempting to install any Increased Safety Window Kit; review all the material and all safety information in this manual and all other applicable documents.



WARNING: Applicable permits must be obtained and appropriate precautions must be taken to prevent possible injury to personnel or equipment damage when installing any Increased Safety Window Kits.



NOTE: Refer to all ATEX, IECEx and UKEx certificates for any Special Conditions of Use. If the sign “X” is placed after the certificate number, it indicates that the equipment or protective system is subject to special conditions for safe use specified in the schedule of the certificate.



NOTE: Review all material and safety information in this manual and install in accordance with this document and all other applicable ATEX, IECEx and UKEx standards.



NOTE: Purge Solutions is NOT responsible for any misuse or improper installation of product, assumes no liability for special or consequential damages caused by use or misuse or improper installation of its products sold and assumes no liability for injury from use or misuse or improper installation of its products or attached products.



WARNING: Failure to heed the information provided may lead to injury of personnel or equipment damage.

Increased Safety Window Kits Installation Procedure:

Purge Solutions, Inc. also offers both opening and non-opening Increased Safety Window Kits in ten (10) standard window viewing sizes, which can be mounted on the door, sides, top or bottom of an enclosure.

If there is not a viewing opening listed in our standard sizes that meets your application requirements; Purge Solutions, Inc. can custom build an opening or non-opening Increased Safety Window Kit for you. As long as the design stays within our conditions of certification no additional assessment and testing is required to maintain ATEX / IECEx certification. Contact Purge Solutions, Inc. to discuss viewing opening needs.

Review all of the material in this manual prior to installing any Increased Safety Window Kit. If you have any questions, please contact your local Purge Solutions, Inc. representative or the factory (refer Getting Help page 27).

Refer to Increased Safety Window Kit, 1/32DIN drawing number MM-11173-A (page 12), 1/16DIN drawing number MM-11172-A (page 13), 1/8DIN drawing number MM-11171-A (page 14), 1/4DIN drawing number MM-11170-A (page 15), X-Large drawing number MM-11169-A (page 16), 9x6 Non-Opening drawing number MM-11290-A (page 17), 14.25x8.75 Non-Opening drawing number MM-11291-A (page 18), 19.5x11.5 Non-Opening drawing number MM-11292-A (page 19), 25x16 Non-Opening drawing number MM-11293-A (page 20), 30x20 Non-Opening drawing number MM-11294-A (page 21), 9x6 Opening drawing number MM-11295-A (page 22), 14.25x8.75 Opening drawing number MM-11296-A (page 23), 19.5x11.5 Opening drawing number MM-11297-A (page 24), 25x16 Opening drawing number MM-11298-A (page 25) or 30x20 Opening drawing number MM-11299-A (page 26), hole sizes and locations required to mount Increased Safety Window Kit to enclosure.

Step 1:

Make sure that area surrounding the enclosure the Increased Safety Window Kit to be installed is known to be non-hazardous.

Step 2:

Make sure that all power is removed from the electrical equipment located in the enclosure where the Increased Safety Window Kit will be installed.

Step 3:

Choose a mounting location for the Increased Safety Window Kit on the enclosure. The chosen location should permit adequate viewing.

Step 4:

Use Mounting Hole Dimensions, Increased Safety Window Kit (drawing number MM-11173-A page 12, MM-11172-A page 13, MM-11171-A page 14, MM-11170-A page 15, MM-11169-A page 16, MM-11290-A page 17, MM-11291-A page 18, MM-11292-A page 19, MM-11293-A page 20, MM-11294-A page 21, drawing number MM-11295-A page 22, MM-11296-A page 23, MM-11297-A page 24, MM-11298-A page 25 or MM-11299-A page 26), to accurately locate the mounting holes and window opening. Use the Mounting Hole Drawing to create a 1 to 1 scale template. Tape the 1 to 1 scale template to the **outside** of enclosure. The required hole locations can then be transferred and / or marked using the centers of the holes as shown on the 1 to 1 scale template.

Step 5:

Drill or punch all holes, per the sizes specified on the Mounting Hole Dimensions, Increased Safety Window Kit (drawing number MM-11173-A page 12, MM-11172-A page 13, MM-11171-A page 14, MM-11170-A page 15, MM-11169-A page 16, MM-11290-A page 17, MM-11291-A page 18, MM-11292-A page 19, MM-11293-A page 20, MM-11294-A page 21, drawing number MM-11295-A page 22, MM-11296-A page 23, MM-11297-A page 24, MM-11298-A page 25 or MM-11299-A page 26).

Step 6:

After required mounting holes have been drilled or punched into enclosure, align the Increased Safety Window Kit to the mounting holes fabricated in Step 5.

Step 7a:***Only For Non-Opening Machined Bezel Models***

Using the mounting hardware provided to mount the Increased Safety Window Kit to enclosure. Make sure that both o-ring seals are properly seated in their associated bezel groove; then tighten fastening hardware to a torque level of 30 - 35 in lbs. (3.4 – 3.9 Nm), which will properly compress o-rings by drawing the bezel tight against the outer surface of the enclosure.

Step 7b:***Only For Opening and Non-Opening Sheet Metal Models***

Using the mounting hardware provided to mount the Increased Safety Window Kit to enclosure. Make sure that all gaskets are installed and properly lined up on their associated flange; then tighten fastening hardware to a torque level of 25 – 30 in lbs. (2.8 – 3.4 Nm), which will properly compress gasket by drawing the flange tight against the outer surface of the enclosure.

Step 8:

After all Increased Safety Window Kit mounting hardware has been properly tightened, the Increase Safety Window Kit is ready to view enclosure internal components.

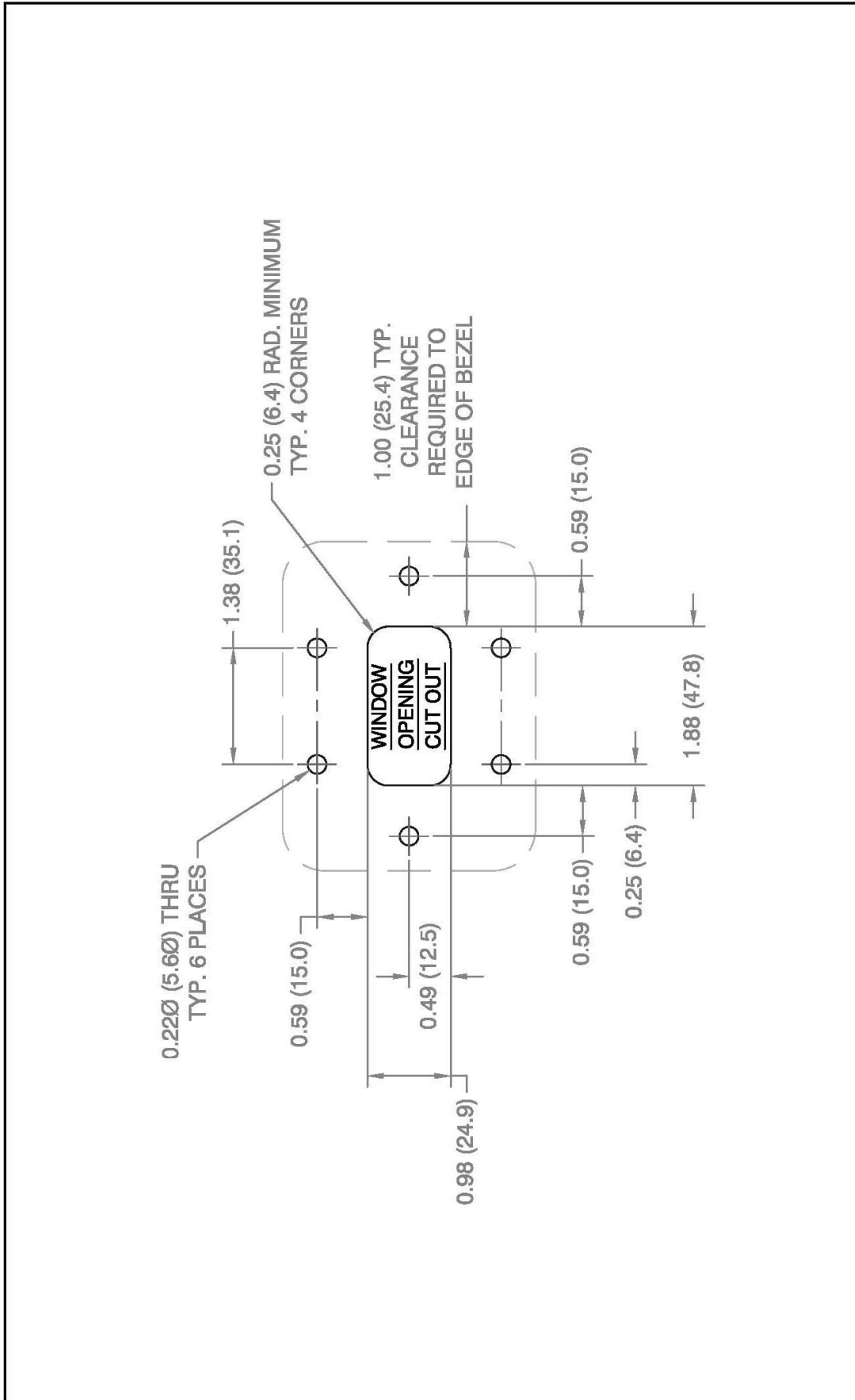

REV #	ECO #	CHANGE(S) DESCRIPTION	DATE	CHANGE BY	APPD BY		
<p>The contents of this drawing is the sole property of Purge Solutions. This print and/or its contents shall not be traced or reproduced without prior written permission from Purge Solutions. It shall not be used directly or indirectly in any way detrimental to the interest of Purge Solutions.</p>		<p>DO NOT SCALE DRAWING UNLESS OTHERWISE SPECIFIED. Dimensions are in inches Dimensions in () are in mm Tolerances: .X = ± 0.015 .XX = ± 0.010 .XXX = ± 0.005 Angular = ±0.1° Break All Sharp Edges SB Minimum Except As Noted</p>		<p>DRAWN: WJT DATE: 02/FEB/12</p> <p>CHECKED: WJT DATE: 02/FEB/12</p> <p>APPROVED: WJT DATE: 02/FEB/12</p>		<p>TITLE: 1/32 DIN MOUNTING HOLE DIMENSIONS INCREASED SAFETY WINDOW KIT</p> <p>PART & DWG #: MM-11173-A</p> <p>SHEET 1 OF 1</p> <p>SCALE: N/A DWG SIZE A</p> <p>MATERIAL: N/A</p> <p>FINISH: N/A</p>	
<p>WEBSTER, TEXAS, USA 832-368-7166</p>							

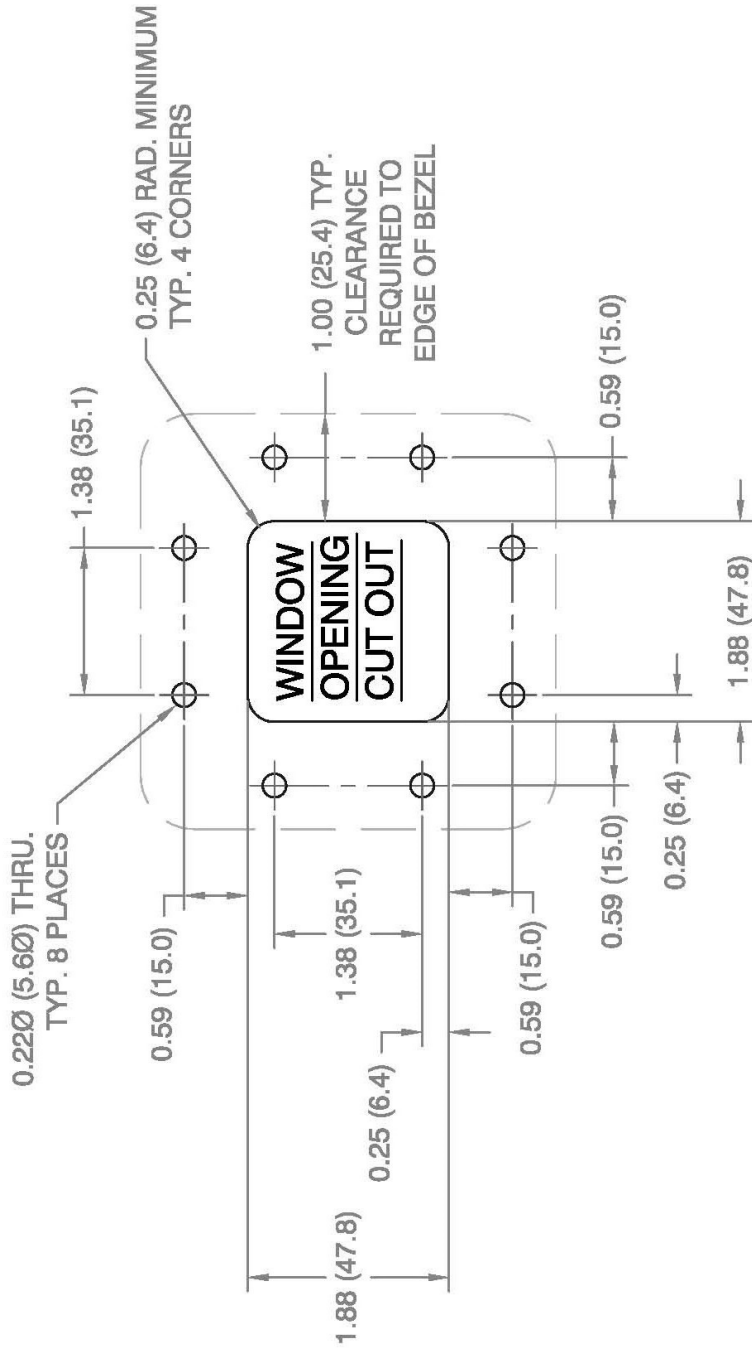

PURGE SOLUTIONS
 WEBSTER, TEXAS, USA
 832-368-7166

TITLE: 1/16 DIN MOUNTING HOLE DIMENSIONS INCREASED SAFETY WINDOW KIT	
PART & DWG. #: MM-11172-A	MATERIAL: N/A
SHEET 1 OF 1	FINISH: N/A
SCALE: N/A	DWG SIZE: A

DRAWN: WJT	DATE: 02/FEB/12
CHECKED: WJT	DATE: 02/FEB/12
APPROVED: WJT	DATE: 02/FEB/12

DO NOT SCALE DRAWING
 UNLESS OTHERWISE SPECIFIED:
 Dimensions in inches
 Dimensions in () are in mm
 Tolerances: X = ± 0.015
 XX = ± 0.010
 XXX = ± 0.005
 Angular = ± 0.5°
 Break All Sharp Edges
 CS Minimum Except As Noted

The contents of this drawing is the sole property of Purge Solutions. This print and/or its contents shall not be traced or reproduced without prior written permission from Purge Solutions. It shall not be used directly or indirectly in any way detrimental to the interest of Purge Solutions.

REV #	ECO #	CHANGE(S) DESCRIPTION	DATE	CHANGE BY	APPD BY

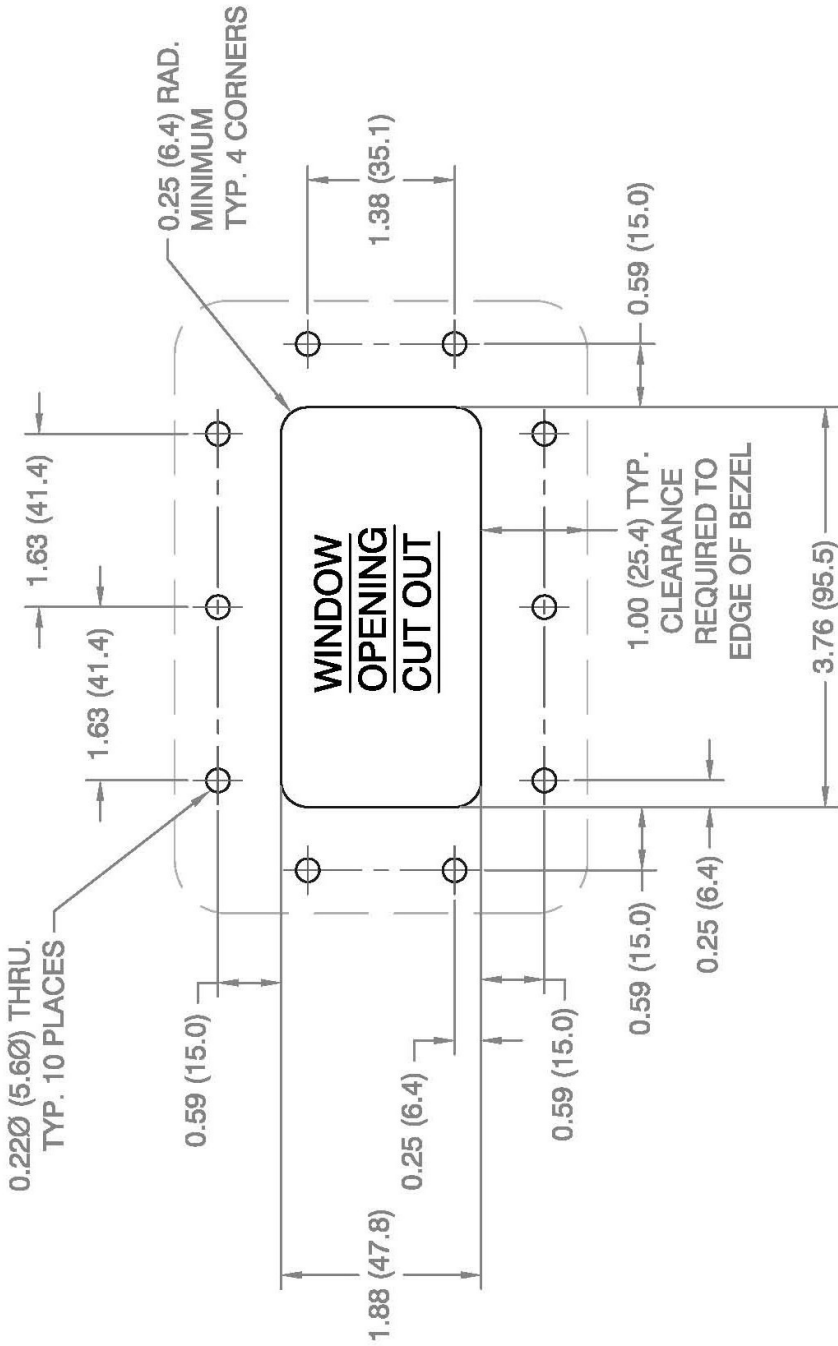

REV #	ECO #	CHANGE(S) DESCRIPTION	DATE	CHANGE BY	APPD BY
<p>DO NOT SCALE DRAWING UNLESS OTHERWISE SPECIFIED. Dimensions Are In Inches Dimensions In () Are In mm Tolerances: X = ± 0.015 XX = ± 0.010 XXX = ± 0.005 Angular = ± 0.5° Break All Sharp Edges B3 Minimum Except As Noted</p>		<p>TITLE: 1/8 DIN MOUNTING HOLE DIMENSIONS INCREASED SAFETY WINDOW KIT</p> <p>PART & DWG #: MM-11171-A MATERIAL: N/A</p> <p>SHEET 1 OF 1</p> <p>SCALE: N/A DWG SIZE: A FINISH: N/A</p>	<p>PURGE SOLUTIONS WEBSTER, TEXAS, USA 832-368-7166</p>		
<p>The contents of this drawing is the sole property of Purge Solutions. This print and/or its contents shall not be traced or reproduced without prior written permission from Purge Solutions. It shall not be used directly or indirectly in any way detrimental to the interest of Purge Solutions.</p>		<p>DRAWN: WJT DATE: 01/FEB/12</p> <p>CHECKED: WJT DATE: 01/FEB/12</p> <p>APPROVED: WJT DATE: 01/FEB/12</p>			

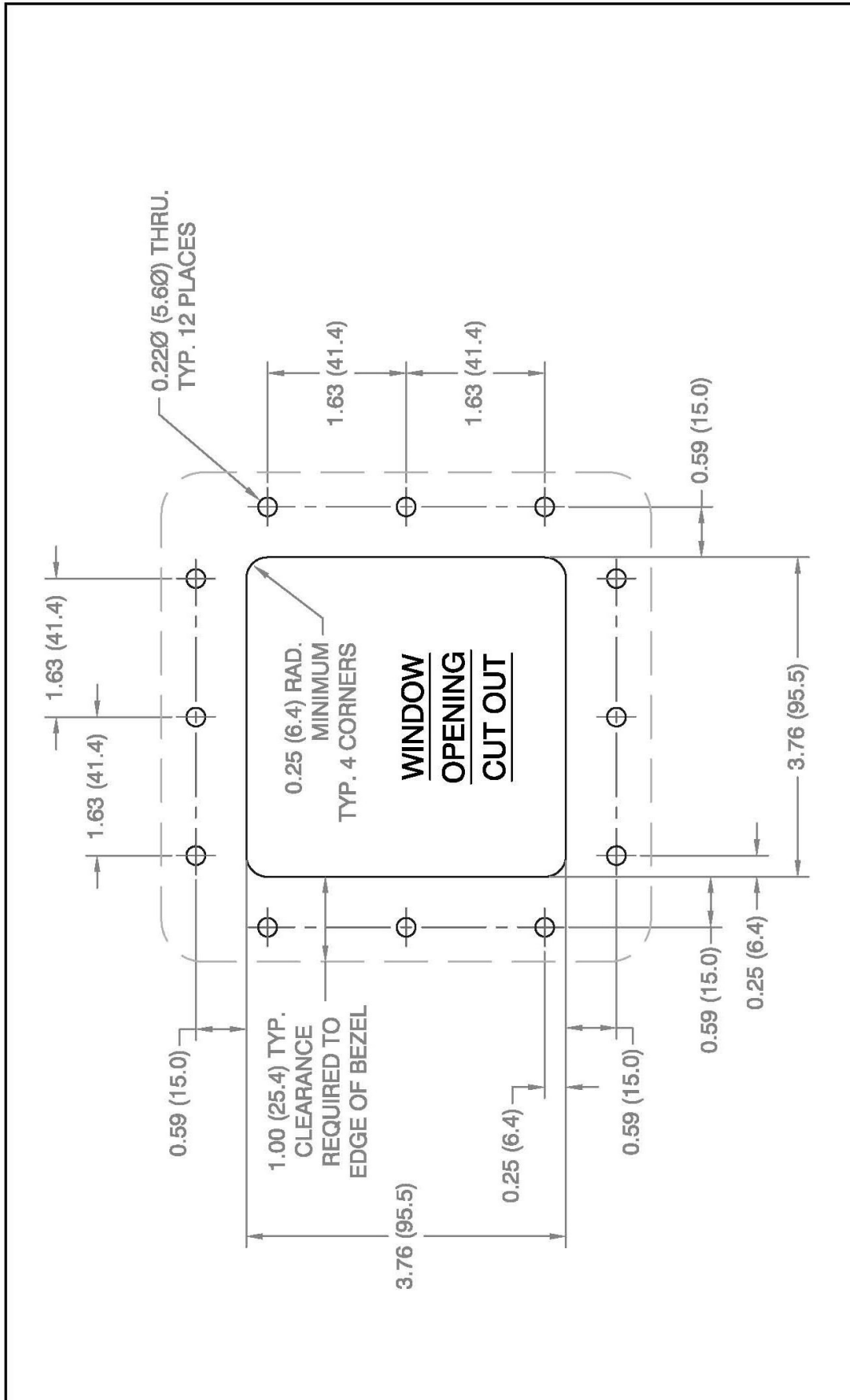

REV #	ECO #	CHANGE(S) DESCRIPTION	DATE	CHANGE BY	APPD BY
<p>DO NOT SCALE DRAWING UNLESS OTHERWISE SPECIFIED. <small>Dimensions Are In Inches Dimensions In () Are In mm</small></p> <p>Tolerances: X = ± 0.015 XX = ± 0.010 XXX = ± 0.005</p> <p>Angular = ± 0.5° B3 Minimum Edge Per Inch</p>			<p>1/4 DIN MOUNTING HOLE DIMENSIONS INCREASED SAFETY WINDOW KIT</p> <p>PART & DWG #: MM-11170-A MATERIAL: N/A</p> <p>SHEET 1 OF 1 DWG SIZE A FINISH: N/A</p>		
<p>The contents of this drawing is the sole property of Purge Solutions. This print and/or its contents shall not be traced or reproduced without prior written permission from Purge Solutions. It shall not be used directly or indirectly in any way detrimental to the Interest of Purge Solutions.</p>			<p>PURGE SOLUTIONS WEBSTER, TEXAS, USA 832-368-7166</p>		
DRAWN:	WJT				
DATE:	01/FEB/12				
CHECKED:	WJT				
DATE:	01/FEB/12				
APPROVED:	WJT				
DATE:	01/FEB/12				

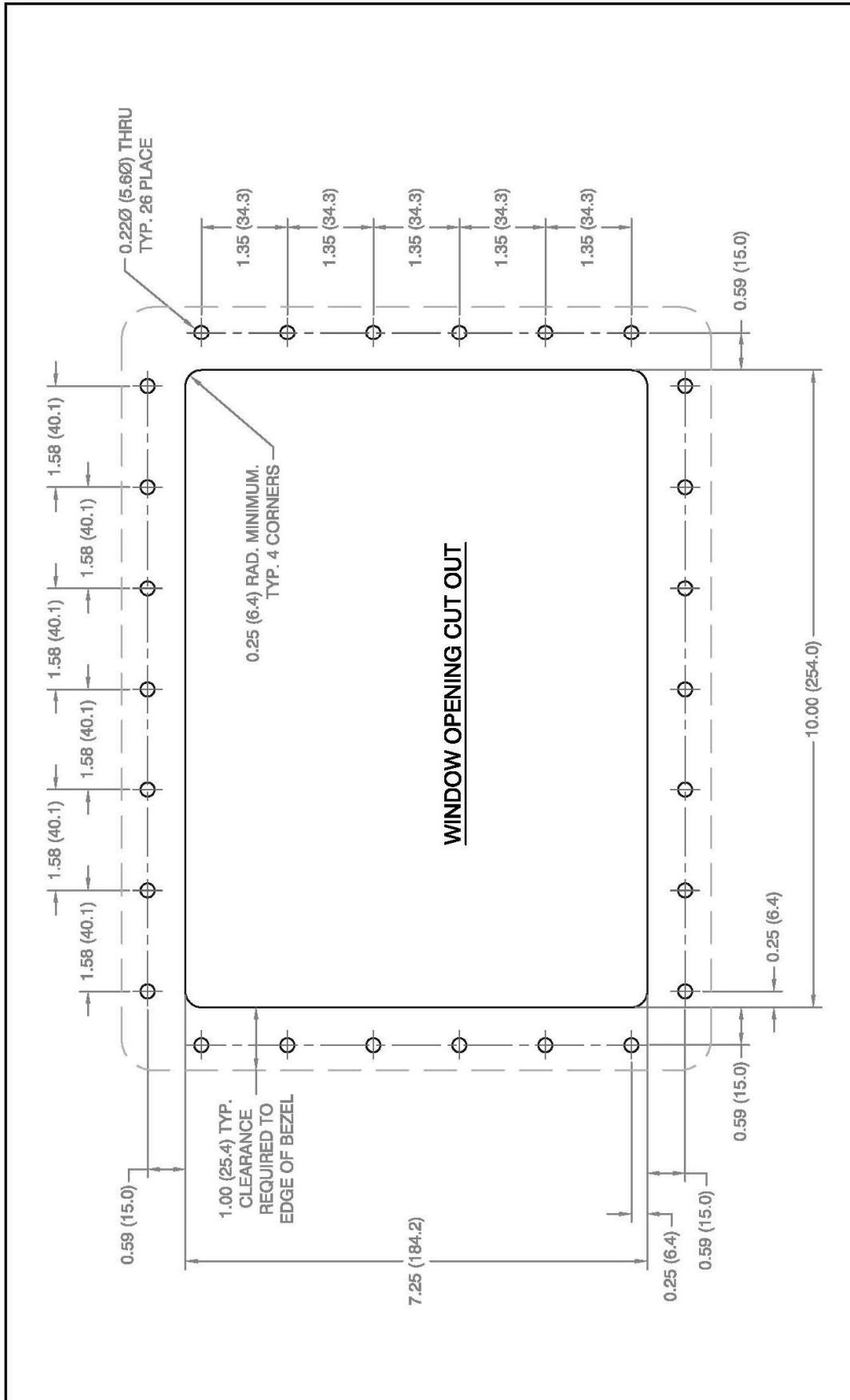

REV #	ECO #	CHANGE(S) DESCRIPTION	DATE	CHANGE BY	APPD BY
		DO NOT SCALE DRAWING UNLESS OTHERWISE SPECIFIED. Dimensions Are in Inches Dimensions in () Are in mm Tolerances: X = ± 0.015 XX = ± 0.010 XXX = ± 0.005 Angular = ± 0.5° Break All Sharp Edges ES Minimum Edge Radii	DRAWN: WJT DATE: 01/FEB/12	TITLE: X-LARGE MOUNTING HOLE DIMENSIONS INCREASED SAFETY WINDOW KIT	
		The contents of this drawing is the sole property of Purge Solutions. This print and/or its contents shall not be traced or reproduced without prior written permission from Purge Solutions. It shall not be used directly or indirectly in any way detrimental to the interest of Purge Solutions.	CHECKED: WJT DATE: 01/FEB/12	MATERIAL: N/A	
			APPROVED: WJT DATE: 01/FEB/12	PART & DWG #: MM-11169-A	
				SHEET 1 OF 1	
				SCALE: N/A DWG SIZE: A FINISH: N/A	
PURGE SOLUTIONS WEBSTER, TEXAS, USA 832-388-7168					

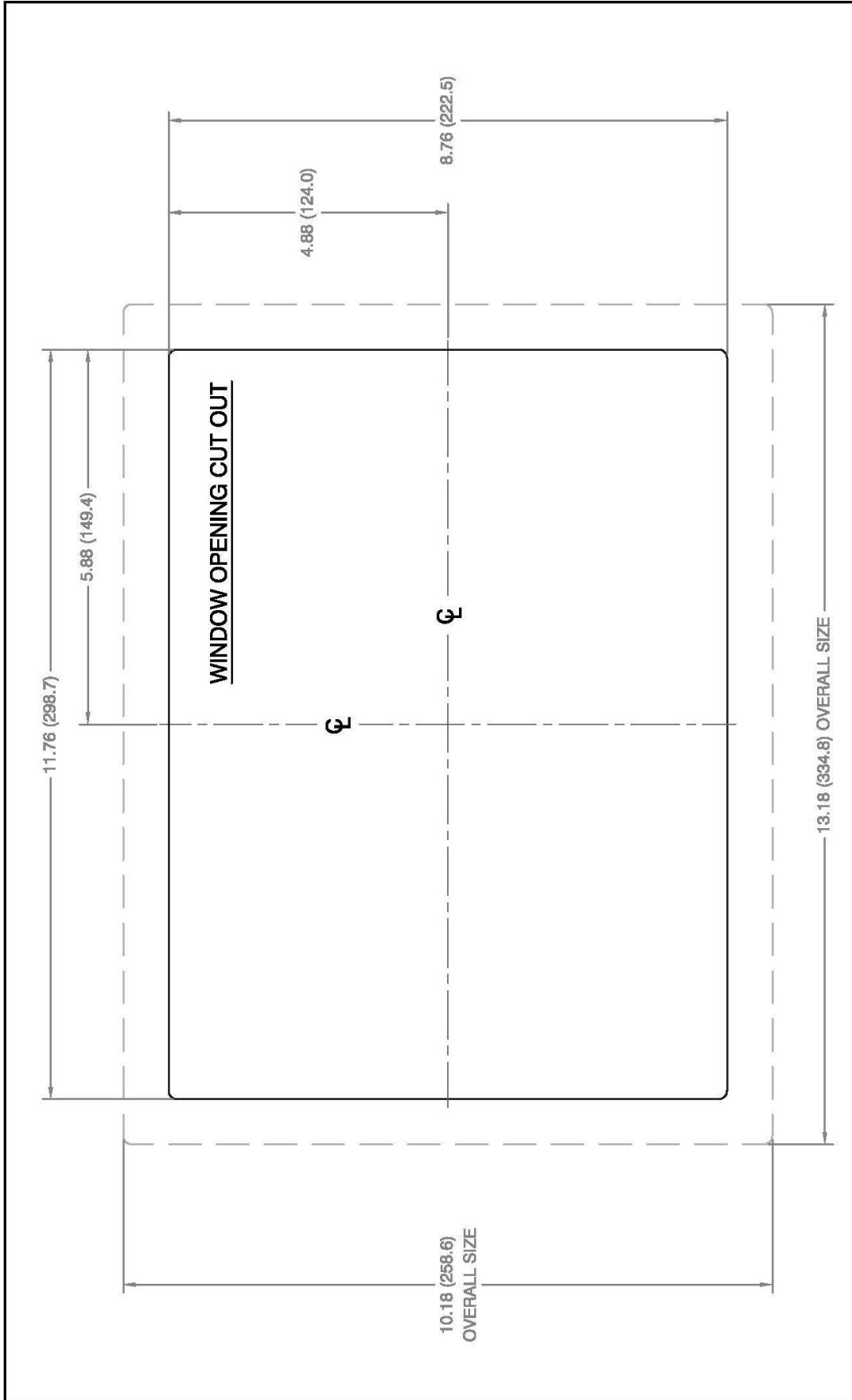

REV #	ECO #	CHANGE(S) DESCRIPTION	DATE	CHANGE BY	APPD BY	
<p>The contents of this drawing is the sole property of Purge Solutions. This print and/or its contents shall not be traced or reproduced without prior written permission from Purge Solutions. It shall not be used directly or indirectly in any way detrimental to the interest of Purge Solutions.</p>		<p>DO NOT SCALE DRAWING. UNLESS OTHERWISE SPECIFIED. Dimensions Are In Inches Dimensions In () Are In mm Tolerances: .X = ± 0.015 .XX = ± 0.010 .XXX = ± 0.005 Angular = 30.5° Break All Sharp Edges ES Minimum Except As Noted</p>		<p>TITLE: 6 X 9 NON-OPENING MOUNTING HOLE DIMENSIONS INCREASED SAFETY WINDOW KIT</p> <p>PART & DWG #: MM-11290-A MATERIAL: N/A</p> <p>SHEET 1 OF 1 SCALE: N/A DWG SIZE A FINISH: N/A</p>		
		<p>DRAWN: WJT DATE: 05/JUL/17</p> <p>CHECKED: WJT DATE: 05/JUL/17</p> <p>APPROVED: WJT DATE: 05/JUL/17</p>	<p>PURGE SOLUTIONS® WEBSTER, TEXAS, USA 832-388-7166</p>			

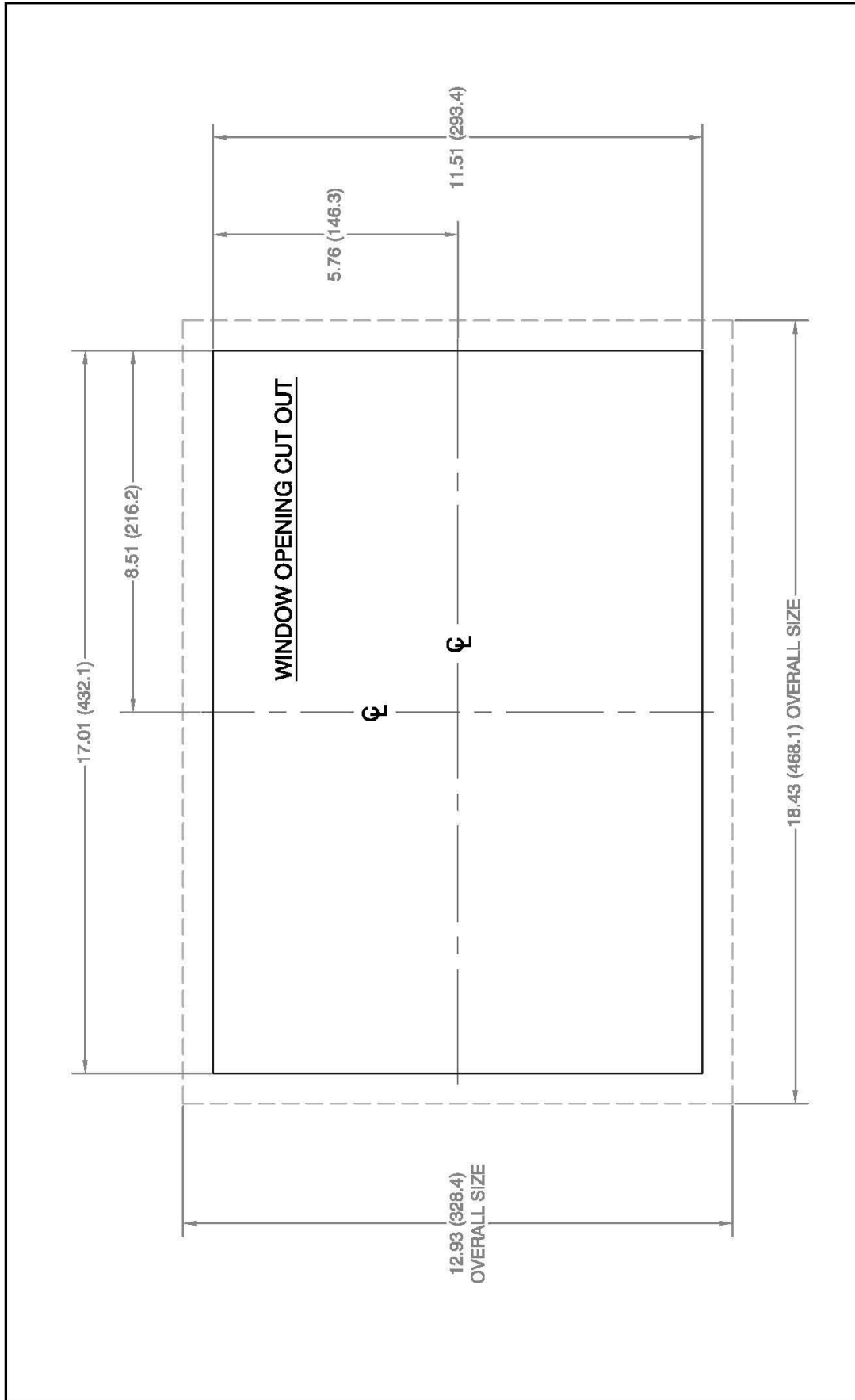

REV #	ECO #	CHANGE(S) DESCRIPTION	DATE	CHANGE BY	APPD BY
<p>DO NOT SCALE DRAWING UNLESS OTHERWISE SPECIFIED. Dimensions are in inches Dimensions in () are in mm Tolerances: X = ± 0.015 XX = ± 0.010 XXX = ± 0.005 Angular = ± 0.5° Break All Sharp Edges SS Medium Sprocket As Noted</p>		<p>TITLE: 8.75 X 14.25 NON-OPENING MOUNTING HOLE DIMENSIONS INCREASED SAFETY WINDOW KIT</p> <p>PART & DWG #: MM-11291-A</p> <p>SHEET 1 OF 1</p> <p>SCALE: N/A DWG SIZE: A FINISH: N/A</p>	<p style="text-align: center;">PURGE SOLUTIONS®</p> <p style="text-align: center;">WEBSTER, TEXAS, USA 832-368-7186</p>		
		<p>DRAWN: WJT DATE: 06/JUL/17</p> <p>CHECKED: WJT DATE: 06/JUL/17</p> <p>APPROVED: WJT DATE: 06/JUL/17</p>	<p>The contents of this drawing is the sole property of Purge Solutions. This print and/or its contents shall not be traced or reproduced without prior written permission from Purge Solutions. It shall not be used directly or indirectly in any way detrimental to the interest of Purge Solutions.</p>		

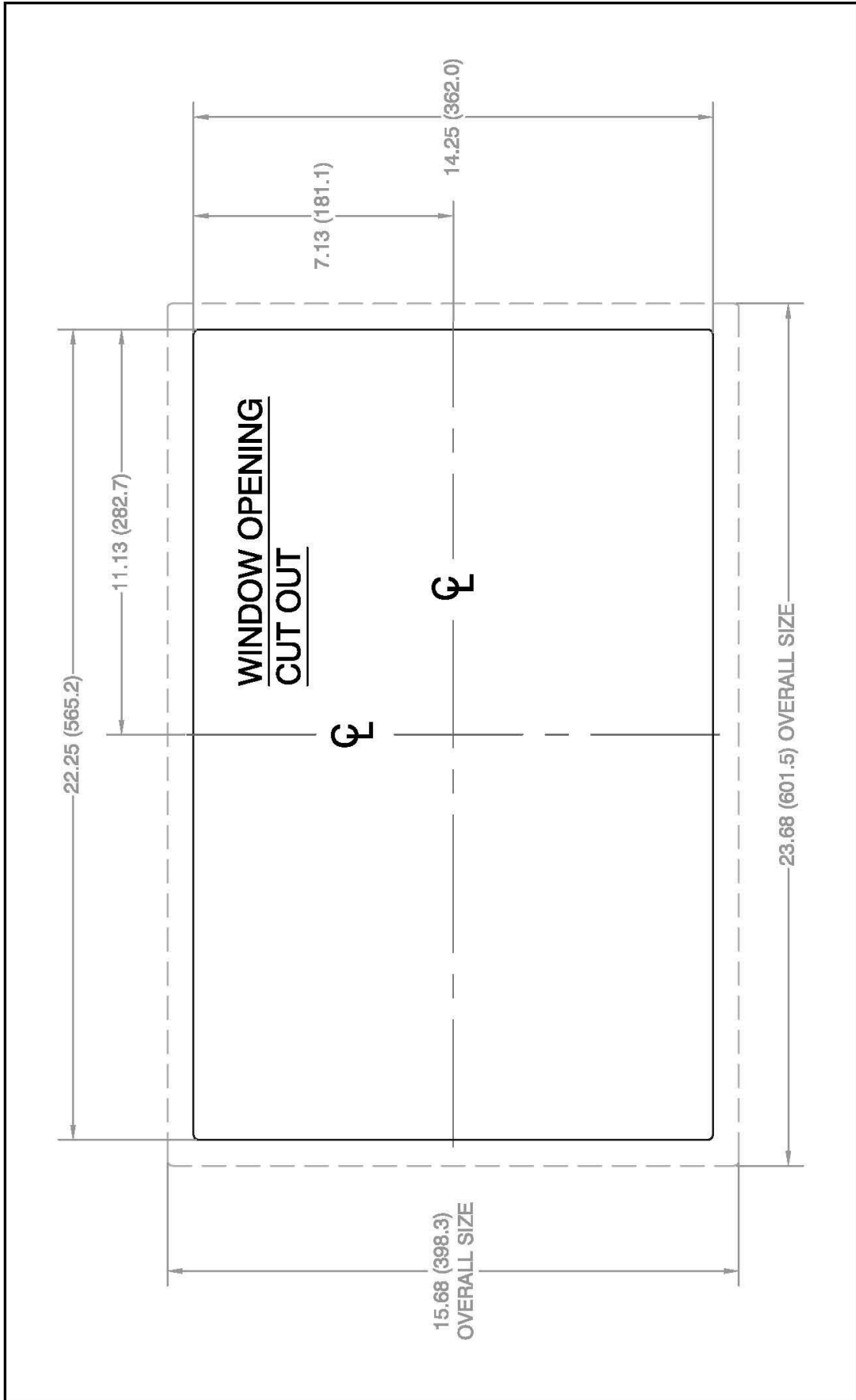

REV #	ECO #	CHANGE(S) DESCRIPTION	DATE	CHANGE BY	APPD BY
<p>DO NOT SCALE DRAWING UNLESS OTHERWISE SPECIFIED: <small>Dimensions are in inches Dimensions in 1/32 in/mm</small></p> <p>Tolerances: .X = ± 0.015 .XX = ± 0.010 .XXX = ± 0.005</p> <p>Angular = ±0.1° Break All Sharp Edges SS Minimum Except As Noted</p>			<p>TITLE: 11.5 X 19.5 NON-OPENING MOUNTING HOLE DIMENSIONS INCREASED SAFETY WINDOW KIT</p> <p>PART & DWG #: MMI-11292-A MATERIAL: N/A</p> <p>SHEET 1 OF 1 SCALE: N/A DWG SIZE A FINISH: N/A</p>		
<p>The contents of this drawing is the sole property of Purge Solutions. This print and/or its contents shall not be traced or reproduced without prior written permission from Purge Solutions. It shall not be used directly or indirectly in any way detrimental to the interest of Purge Solutions.</p>			<p>DRAWN: WJT DATE: 05/JUL/17</p> <p>CHECKED: WJT DATE: 05/JUL/17</p> <p>APPROVED: WJT DATE: 05/JUL/17</p>		



ALVIN, TEXAS, USA
 832-368-7166

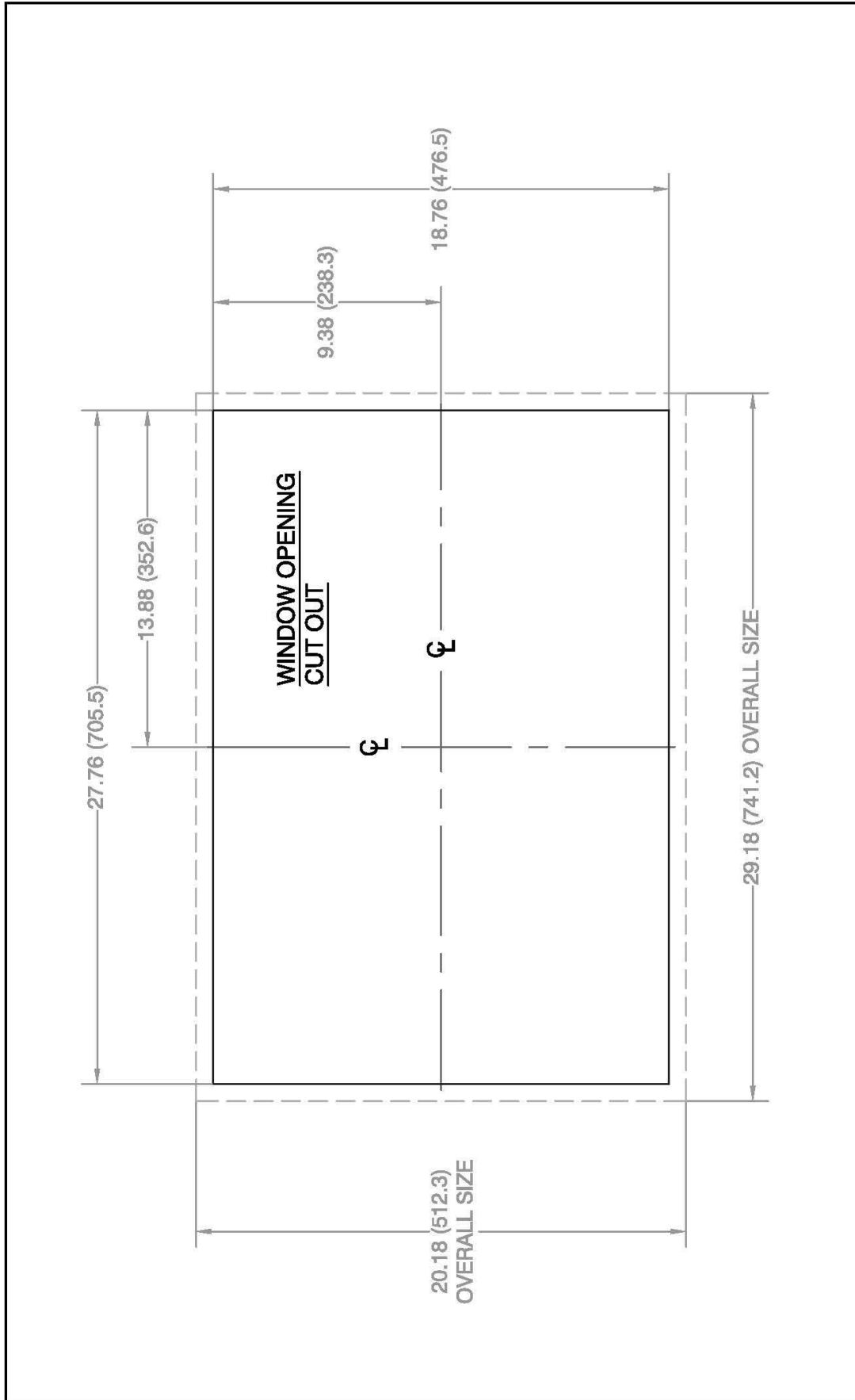

REV #	ECO #	CHANGE(S) DESCRIPTION	DATE	CHANGE BY	APPD BY
<p>DO NOT SCALE DRAWING UNLESS OTHERWISE SPECIFIED: Dimensions are in inches Dimensions in () are in mm Tolerances: X = ± 0.015 XX = ± 0.010 XXX = ± 0.005 Angular -10.0° Break All Sharp Edges ES Minimum Escapement As Noted</p>		<p>TITLE: 16 X 25 NON-OPENING MOUNTING HOLE DIMENSIONS INCREASED SAFETY WINDOW KIT</p> <p>PART & DWG #: MM-11283-A</p> <p>SHEET 1 OF 1</p> <p>SCALE: N/A DWG SIZE: A</p> <p>MATERIAL: N/A</p> <p>FINISH: N/A</p>	<p>DRAWN: WJT DATE: 06/JUL/17</p> <p>CHECKED: WJT DATE: 06/JUL/17</p> <p>APPROVED: WJT DATE: 06/JUL/17</p>	<p>ALVIN, TEXAS, USA 832-368-7186</p>	
<p>The contents of this drawing is the sole property of Purge Solutions. This print and/or its contents shall not be traced or reproduced without prior written permission from Purge Solutions. It shall not be used directly or indirectly in any way detrimental to the interest of Purge Solutions.</p>					

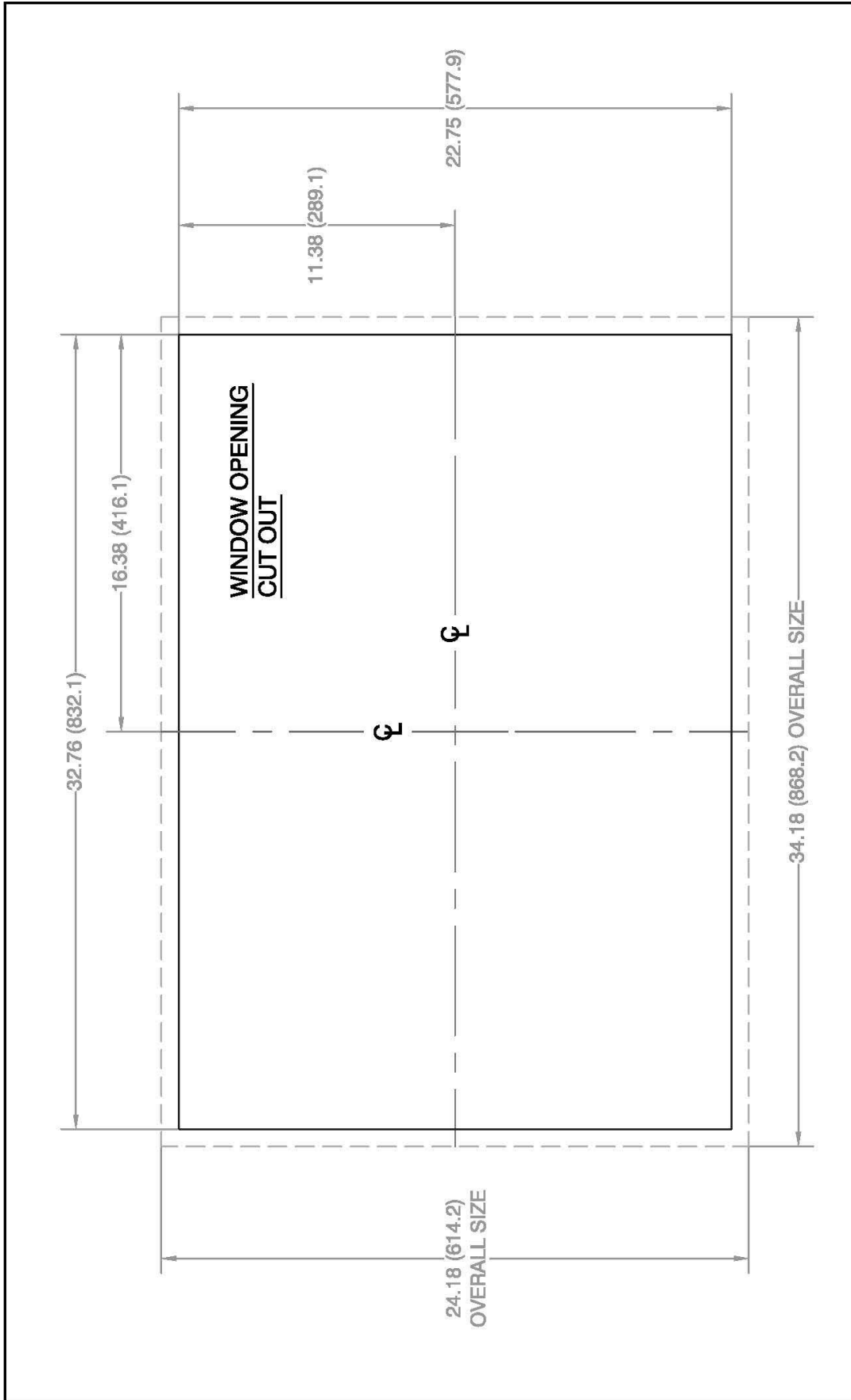

REV #	ECO #	CHANGE(S) DESCRIPTION	DATE	CHANGE BY	APPD BY	
<p>The contents of this drawing is the sole property of Purge Solutions. This print and/or its contents shall not be traced or reproduced without prior written permission from Purge Solutions. It shall not be used directly or indirectly in any way detrimental to the interest of Purge Solutions.</p>		<p>DO NOT SCALE DRAWING. UNLESS OTHERWISE SPECIFIED: Dimensions in Inches Dimensions in () are in mm Tolerances: .X = ± 0.015 .XX = ± 0.010 .XXX = ± 0.005 Angular = ±0.5° Break All Sharp Edges SS Minimum Excep/As Noted</p>		<p>TITLE: 20 X 30 NON-OPENING MOUNTING HOLE DIMENSIONS INCREASED SAFETY WINDOW KIT</p> <p>MATERIAL: N/A</p> <p>PART & DWG #: MM-11294-A</p> <p>SHEET 1 OF 1</p> <p>SCALE: N/A DWG SIZE A FINISH: N/A</p>		
		DRAWN: WJT	DATE: 05/JUL/17			
		CHECKED: WJT	DATE: 05/JUL/17			
		APPROVED: WJT	DATE: 05/JUL/17			



ALVIN, TEXAS, USA
832-388-7166

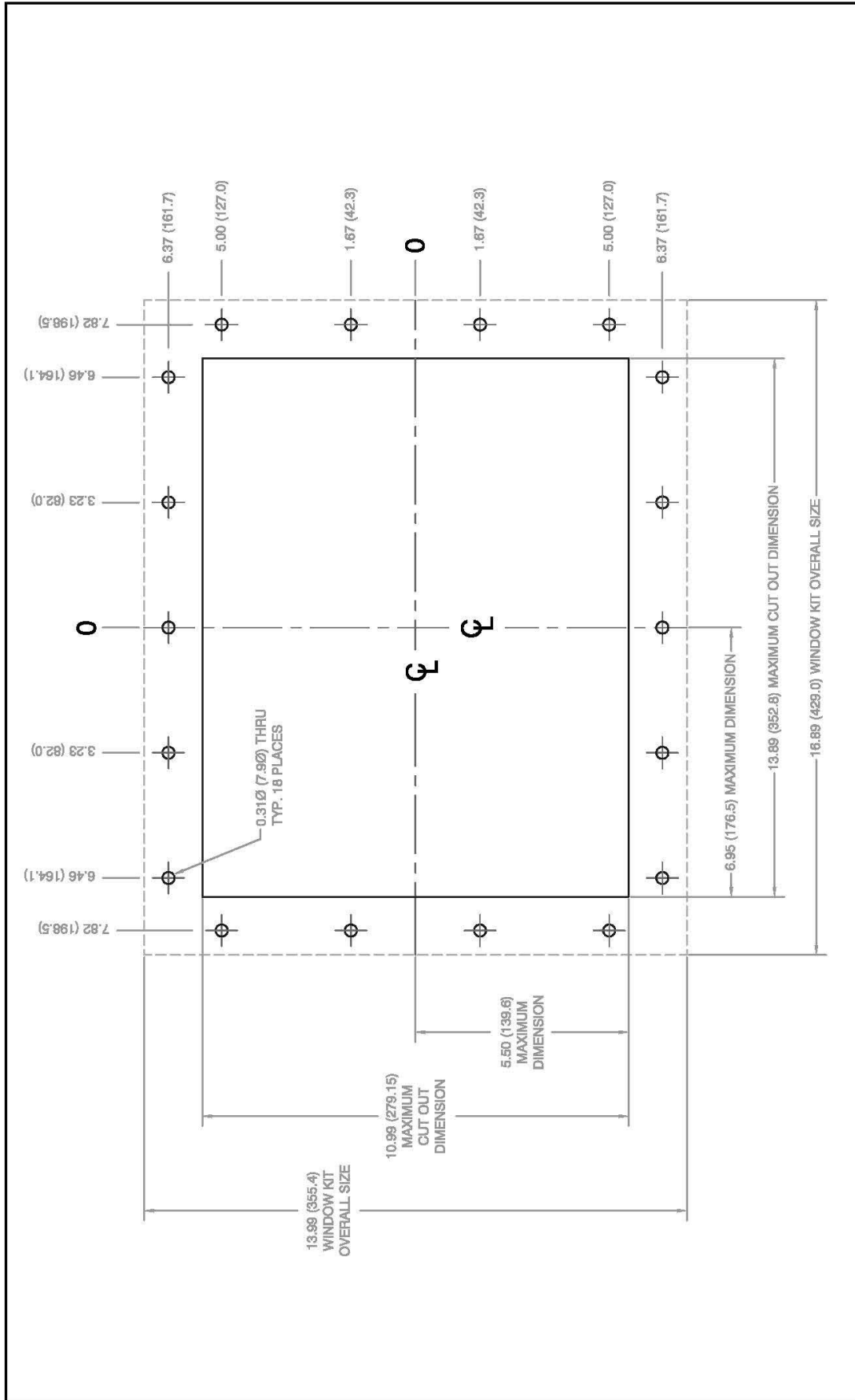

REV #	ECO #	CHANGE(S) DESCRIPTION	DATE	CHANGE BY	APPD BY
<p>DO NOT SCALE DRAWING. UNLESS OTHERWISE SPECIFIED. Dimensions Are In Inches Dimensions In () Are In mm Tolerances: .X = ± 0.015 .XX = ± 0.010 .00X = ± 0.005 Angular = ± 0.5° Break All Sharp Edges ES Minimum Except As Noted</p>			<p>6 X 9 HOLE CUT OUT DETAILS OPENING INCREASED SAFETY WINDOW KIT</p>		
<p>The contents of this drawing is the sole property of Purge Solutions. This print and/or its contents shall not be traced or reproduced without prior written permission from Purge Solutions. It shall not be used directly or indirectly in any way detrimental to the interest of Purge Solutions.</p>			<p>PURGE SOLUTIONS® ALVIN, TEXAS, USA 832-388-7166</p>		
<p>DRAWN: WJT DATE: 11/FEB/17</p>			<p>PART & DWG #: DO-11295-A MATERIAL: N/A</p>		
<p>CHECKED: WJT DATE: 11/FEB/17</p>			<p>SHEET 1 OF 1 DWG SIZE A</p>		
<p>APPROVED: WJT DATE: 11/FEB/17</p>			<p>FINISH: N/A</p>		

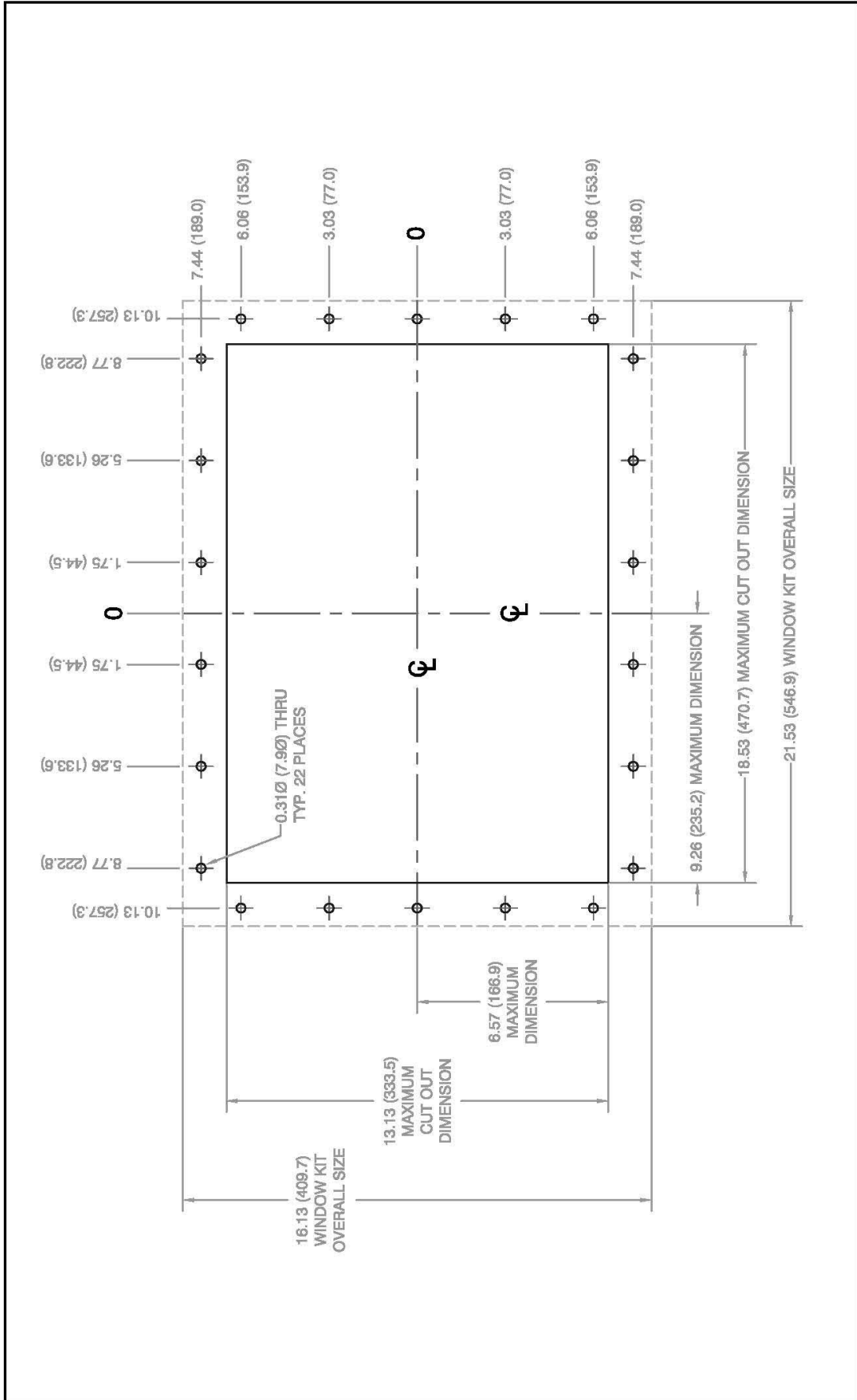

REV #	ECO #	CHANGE(S) DESCRIPTION	DATE	CHANGE BY	APPD BY
<p>The contents of this drawing is the sole property of Purge Solutions. This print and/or its contents shall not be traced or reproduced without prior written permission from Purge Solutions. It shall not be used directly or indirectly in any way detrimental to the interest of Purge Solutions.</p>		<p>DO NOT SCALE DRAWING. UNLESS OTHERWISE SPECIFIED: Dimensions Are In Inches Dimensions In () Are In mm Tolerances: X = ± 0.015 XX = ± 0.010 XXX = ± 0.005 Angular = ±0.5° Break All Sharp Edges B3 Minimum Except As Noted</p>		<p>TITLE: 8.75 X 14.25 HOLE CUT OUT DETAILS OPENING INCREASED SAFETY WINDOW KIT</p>	
<p>DRAWN: WJT DATE: 11/FEB/17</p>		<p>PART & DWG #: DO-11296-A</p>		<p>MATERIAL: N/A</p>	
<p>CHECKED: WJT DATE: 11/FEB/17</p>		<p>SHEET 1 OF 1</p>		<p>FINISH: N/A</p>	
<p>APPROVED: WJT DATE: 11/FEB/17</p>		<p>SCALE: N/A</p>		<p>DWG SIZE: A</p>	



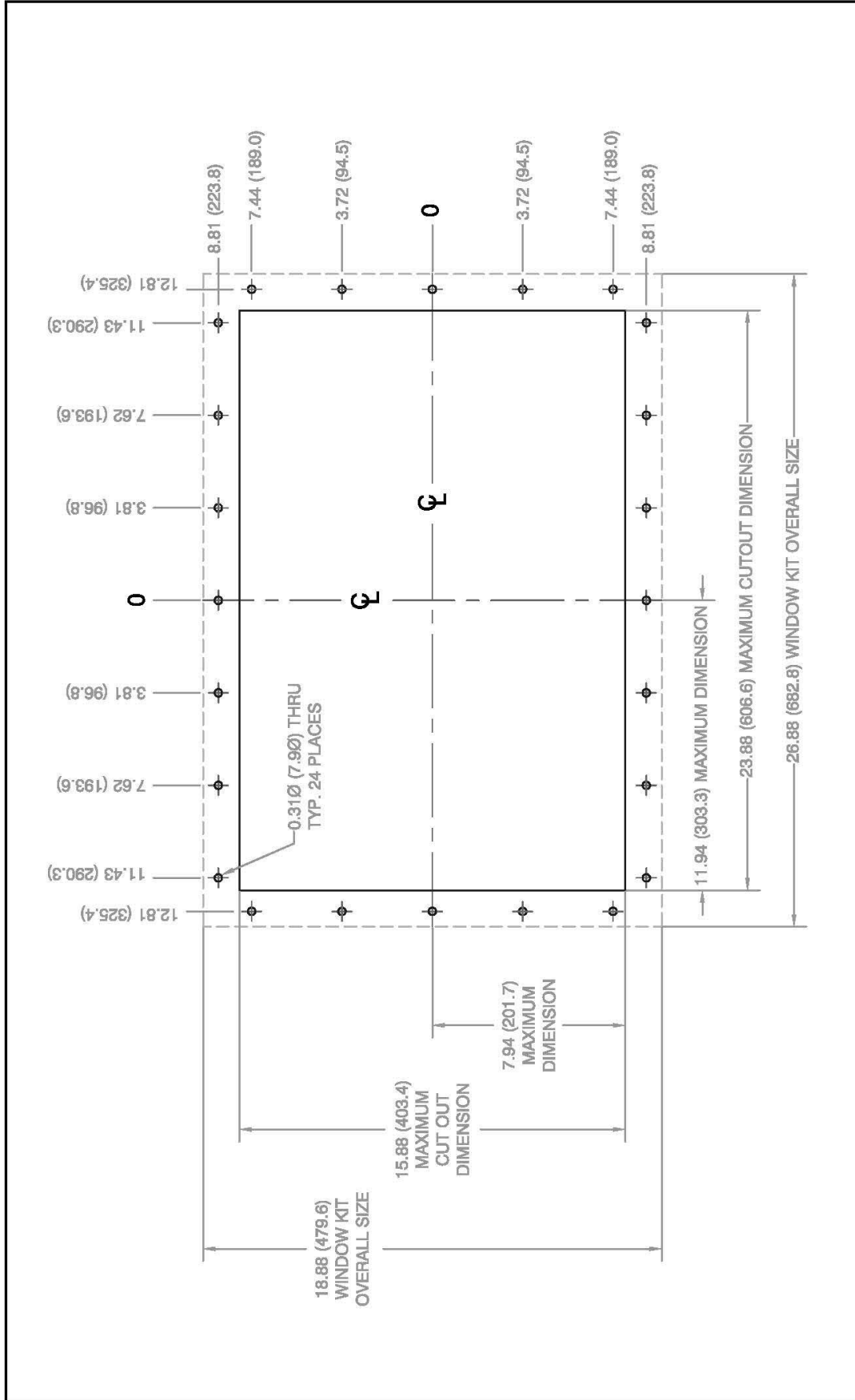

REV #	ECO #	CHANGE(S) DESCRIPTION	DATE	CHANGE BY	APPD BY
<p>DO NOT SCALE DRAWING. UNLESS OTHERWISE SPECIFIED: Dimensions Are in inches Dimensions in () Are in mm</p> <p>Tolerances: X = ± 0.015 XX = ± 0.010 XXX = ± 0.005</p> <p>Angular = ±0.5° Break All Sharp Edges ES Minimum Except As Noted</p>			<p>TITLE: 11.5 X 19.5 OPENING MOUNTING HOLE DIMENSIONS INCREASED SAFETY WINDOW KIT</p> <p>PART & DWG #: MM-11297-A MATERIAL: N/A</p> <p>SHEET 1 OF 1</p> <p>SCALE: N/A DWG SIZE A FINISH: N/A</p>		
<p>The contents of this drawing is the sole property of Purge Solutions. This print and/or its contents shall not be traced or reproduced without prior written permission from Purge Solutions. It shall not be used directly or indirectly in any way detrimental to the interest of Purge Solutions.</p>			<p>DRAWN: WJT DATE: 14/JUL/17</p> <p>CHECKED: WJT DATE: 14/JUL/17</p> <p>APPROVED: WJT DATE: 14/JUL/17</p>		



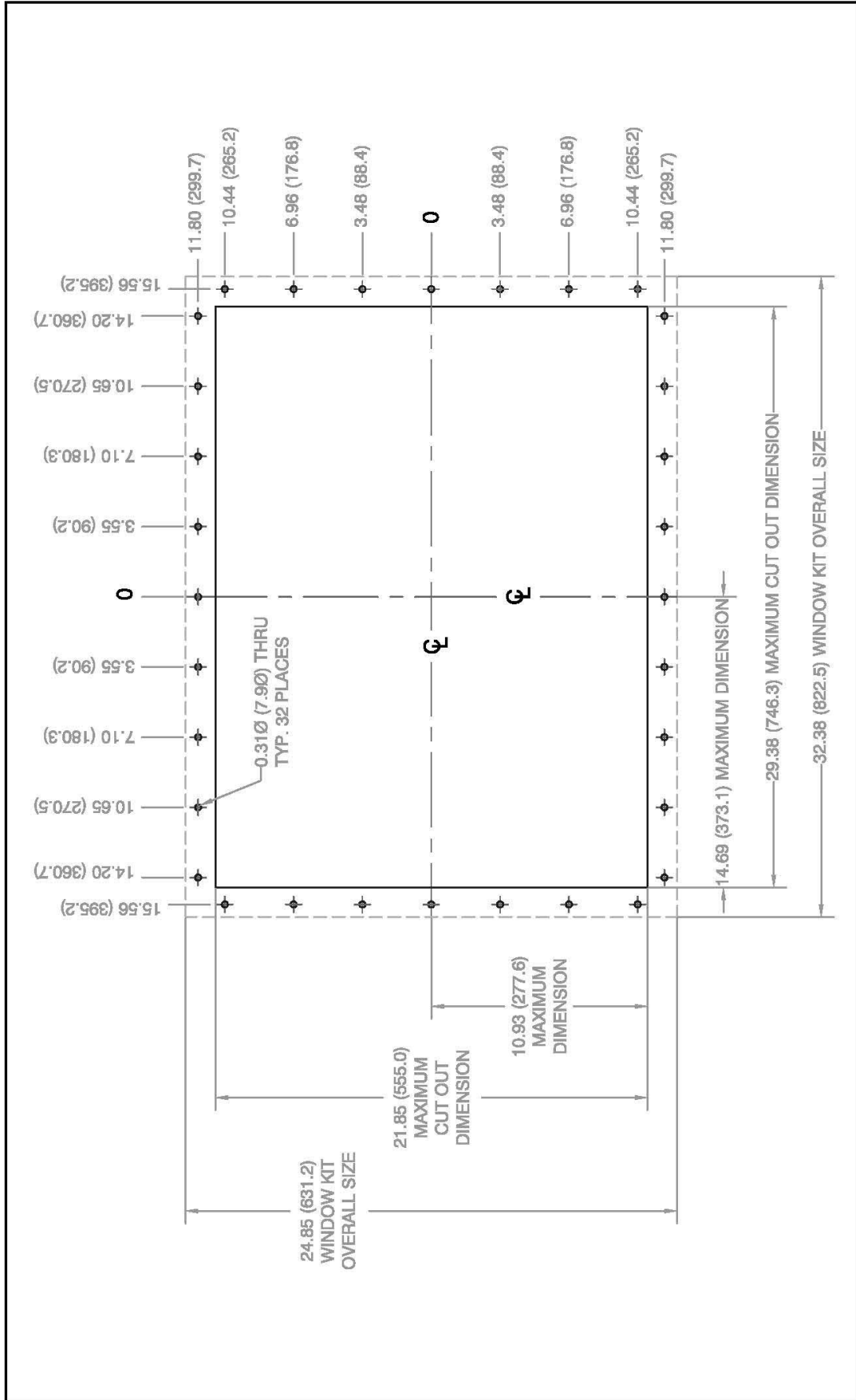

REV #	ECO #	CHANGE(S) DESCRIPTION	DATE	CHANGE BY	APPD BY
<p>DO NOT SCALE DRAWING. UNLESS OTHERWISE SPECIFIED: Dimensions Are In Inches Dimensions In () Are In mm Tolerances: X = ± 0.015 .XX = ± 0.010 .XXX = ± 0.005 Angular = ± 0.5° Break All Sharp Edges B3 Minimum Except As Noted</p>			<p>TITLE: 16 X 25 HOLE CUT OUT DETAILS OPENING INCREASED SAFETY WINDOW KIT</p> <p>PART & DWG #: DO-11298-A MATERIAL: N/A</p> <p>SHEET 1 OF 1 SCALE: N/A DWG SIZE: A FINISH: N/A</p>		
<p>The contents of this drawing is the sole property of Purge Solutions. This print and/or its contents shall not be traced or reproduced without prior written permission from Purge Solutions. It shall not be used directly or indirectly in any way detrimental to the interest of Purge Solutions.</p>			<p>DRAWN: WJT DATE: 11/FEB/17 CHECKED: WJT DATE: 11/FEB/17 APPROVED: WJT DATE: 11/FEB/17</p>		



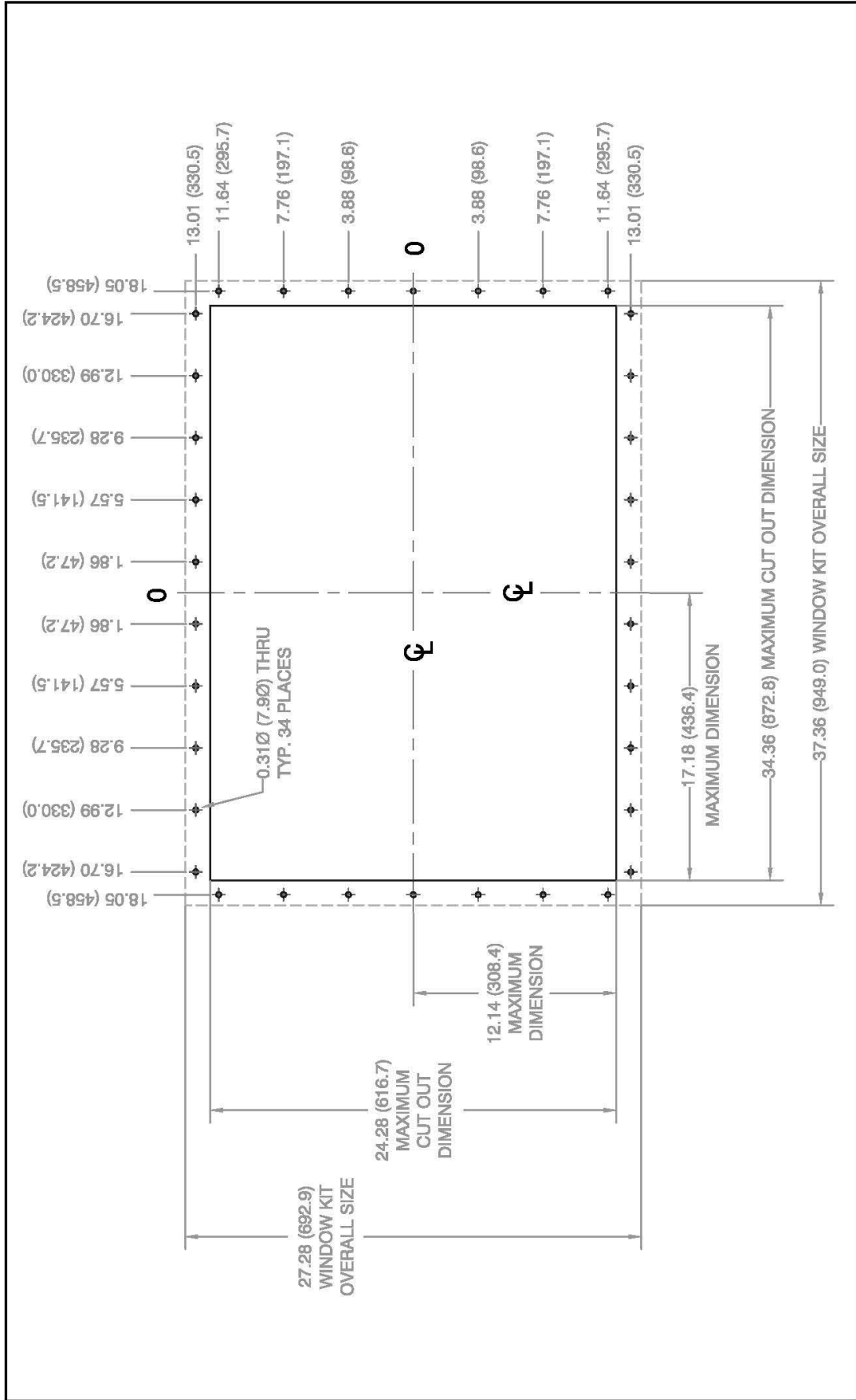

REV #	ECO #	CHANGE(S) DESCRIPTION	DATE	CHANGE BY	APPD BY
<p>DO NOT SCALE DRAWING. UNLESS OTHERWISE SPECIFIED: Dimensions Are In Inches Dimensions In () Are In mm Tolerances: X = ± 0.015 XX = ± 0.010 XXX = ± 0.005 Angular = ± 0.5° Break All Sharp Edges ES Minimum Except As Noted</p>			<p>TITLE: 20 X 30 HOLE CUT OUT DETAILS OPENING INCREASED SAFETY WINDOW KIT</p> <p>PART & DWG #: DO-11299-A MATERIAL: N/A</p> <p>SHEET 1 OF 1 SCALE: N/A DWG SIZE A FINISH: N/A</p>		
<p>The contents of this drawing is the sole property of Purge Solutions. This print and/or its contents shall not be traced or reproduced without prior written permission from Purge Solutions. It shall not be used directly or indirectly in any way detrimental to the interest of Purge Solutions.</p>			<p>DRAWN: WJT DATE: 11/FEB/17</p> <p>CHECKED: WJT DATE: 11/FEB/17</p> <p>APPROVED: WJT DATE: 11/FEB/17</p>		
<p>PURGE SOLUTIONS® ALVIN, TEXAS, USA 832-388-7166</p>					

Section 4

Getting Help

Getting Help:

Answers to many questions concerning any optional products we offer are in this manual. If a problem or question is encountered that is not covered in the documentation provided, assistance is available Monday through Friday (except holidays), from 8 a.m. to 5 p.m. United States central time. To obtain assistance by telephone call Purge Solutions, Inc. at **832-368-7166**.

For assistance during times other than normal business hours, consult our World Wide Web Internet site at **<http://www.purgesolutions.com>**. This site includes equipment information, news releases, videos and other information. E-mail can be sent to **info@purgesolutions.com**.

Purge Solutions, Inc. Standard Terms and Conditions of Sale

The product, equipment, software, material and / or services (collectively the "Product"), which are described in our quotation, purchase order acknowledgment, packing list and / or invoice hereof shall be sold by Purge Solutions, Inc. only upon the following Standard Terms and Conditions of Sale:

1. **CONTRACT TERMS AND ACCEPTANCE OF PURCHASE ORDER:** These Standard Terms and Conditions of Sale (the "Contract") are the only terms and conditions applicable to the sale of the Products, which are based on qualification and completion of the following: a) Acceptance of any Purchase Order is subject to credit approval by Purge Solutions, Inc. b) Acceptance of completed Purge Solutions, Inc. Customer Information Form. c) Final acceptance of Purchase Order will be Purchase Order Acknowledgment being forwarded to Buyer *(Only until Purchase Order Acknowledgment has been forwarded to Buyer has purchase order been accepted and sent to manufacturing for processing.)*
 2. **QUOTATION PRICES:** Quoted prices are valid for thirty (30) days of quotation date and are exclusive of any applicable taxes, shipping charges and / or any other miscellaneous charges not specified in quote. Prices are subject to change without notice. Any change in quantities, partial release and / or destination may incur a price adjustment.
 3. **PAYMENT TERMS:** Purchase Orders inside the Continental United States; are subject to the approval of Purge Solutions, Inc. Credit Department and unless otherwise agreed in writing, terms of payment are NET thirty (30) days following the date of invoice. Purchase orders outside the continental United States, will be shipped upon receipt of full payment and all costing in US dollars. When the purchase order has been acknowledged, an invoice will be provided. When full payment has been received, including shipping and handling charges, purchase order will be shipped. Purge Solutions, Inc. accepts Visa, MasterCard, Discover and American Express as well as banking transfers. Banking transfer fees are not shared and if banking transfer fees are incorrect; purchase orders will not be shipped. If any Buyer fails to comply with these terms and conditions or sale or if Buyer's credit becomes unsatisfactory to Purge Solutions, Inc., Purge Solutions, Inc. reserves the right to terminate the purchase order without liability to Purge Solutions, Inc. and all future purchase orders of Buyer will be COD or credit card terms before shipping. If a company has an outstanding invoice that is five (5) days past the due date, open purchase orders are subject to being held until such time as the past due status has been brought current.
 4. **DELIVERY DATES:** Quoted delivery dates are approximate estimates determined at the time of quotation and are subject to revisions due to variations in order processing and new purchase orders in manufacturing queue since quoting. Purge Solutions, Inc. assumes no liability for losses arising from inaccurate lead time estimates and is able to make partial shipments against this Contract. The Buyer shall not hold Purge Solutions, Inc. responsible for any delay or damages suffered by the Buyer by reason of any delay due to fires, strikes, riots, Acts of God, priorities, Government orders or restrictions, delays by suppliers or materials or parts, inability to obtain suitable and sufficient labor and / or any other unavoidable contingencies beyond the control of Purge Solutions, Inc. In no case shall Purge Solutions, Inc. be liable for any consequential or special damages arising from any delay in delivery. In the event of such delay, the shipping date shall be extended for a period equal to the time lost by reason of such delay.
 5. **CANCELLATIONS:** Only prior to shipping of Product may Buyer terminate purchase order providing the following: a) Purge Solutions, Inc. is given reasonable notice. b) Purge Solutions, Inc. is compensated for all costs, expenses incurred or committed and for any losses resulting. Once a purchase order has been shipped, all sales are final.
 6. **CLAIMS, DAMAGE OR LOSS IN TRANSIT:** Delivery of Product to carrier from Purge Solutions, Inc. facility or other shipping point shall constitute delivery. Buyer shall bear the risk of loss for damage to or loss of Product from the time Purge Solutions, Inc. delivers Product to carrier, Buyer or Buyer agent. Any claims for damage or loss, which has passed to the Buyer shall be filed with the carrier. Buyer shall give written notice to Purge Solutions, Inc. of any claim for shortage or error in Product shipped within five (5) days of receipt of Product.
 7. **WARRENTY AND LIMITATION OF LIABILITY:** Purge Solutions, Inc. Products are warranted free from defects in material and workmanship at the time of shipment for one year thereafter (One year from date of shipping.). Any claimed defects with Purge Solutions, Inc. Products must be reported within the warranty period and warranty subject to inspection by Purge Solutions, Inc. All warranty inspections are to be performed at Purge Solutions, Inc. facility. Buyer shall ship with shipping charges paid by the Buyer to Purge Solutions, Inc. facility. After inspection by Purge Solutions, Inc. a quotation of proposed work required will be sent to the Buyer. Purge Solutions, Inc. shall be liable only to replace or repair, at its option, free of charge, Products which are found by Purge Solutions, Inc. to be defective in material or workmanship, and which are reported to Purge Solutions, Inc. within the warranty period as provide previously. This right of replacement shall be Buyer's exclusive remedy against Purge Solutions, Inc. Shipment of repaired or replaced products from Purge Solutions, Inc. facility shall be ex-works or FOB Purge Solutions, Inc. facility. Purge Solutions, Inc. shall not be liable for labor charges or other losses or damages of any kind or description, including but not limited to, incidental, special or consequential damages caused by defective Products. This warranty shall be void if product specifications provided by Purge Solutions, Inc. are not followed concerning methods of installation, operation, usage, storage or exposure to harsh conditions (including, but not limited to, temperature and humidity levels outside the approved ranges). Products furnished by Purge Solutions, Inc. by other suppliers shall carry no warranty except that supplier's warranties as to materials and workmanship. Purge Solutions, Inc. disclaims all warranties, expressed or implied, with respect to such Products. The express warranties set forth herein constitute the only warranties with respect to the products sold in connection herewith. Purge Solutions, Inc. makes no representation or warranty of any kind, express or implied (either in fact or by operation of law), with respect to the Products, whether as to their merchantability, fitness for a particular purpose or otherwise. No employee, agent or representative of Purge Solutions, Inc. has any authority to bind Purge Solutions, Inc. to any oral or written representation or warranty concerning the Products over and above that stated herein, except by written amendment signed by Purge Solutions, Inc. and Buyer.
 8. **RETURNS:** Subject to the terms of this Contract regarding CANCELLATION and WARRANTY, All sales are final. Buyer may request a warranty return by contacting Purge Solutions, Inc. and requesting a Return Merchandise Authorization Number. No Product will be accepted for return without a valid Return Merchandise Authorization form and clearly noted on the outside of the shipment. Any return shipment must be made by prepaid freight unless Purge Solutions, Inc. has expressly authorized Buyer in writing to ship such Product to Purge Solutions, Inc. at Purge Solutions, Inc. expense. Any returns of Product authorized by Purge Solutions, Inc. under certain circumstances are subject to a standard restocking charge of 25% of the purchase order's invoice. Non-stock Products are subject to higher restocking charges, if return privileges are extended.
 9. **SERVICES:** Services rendered by Purge Solutions, Inc. whether with or without charge, are only advisory in nature and are only merely incidental to the sales of the Product. When any such services are rendered, Buyer will retain full responsibility for and full control, custody and supervision of the Product, its installation, selection thereof and a representative of Buyer shall be present with full authority to direct operations.
-